

Compact C Range

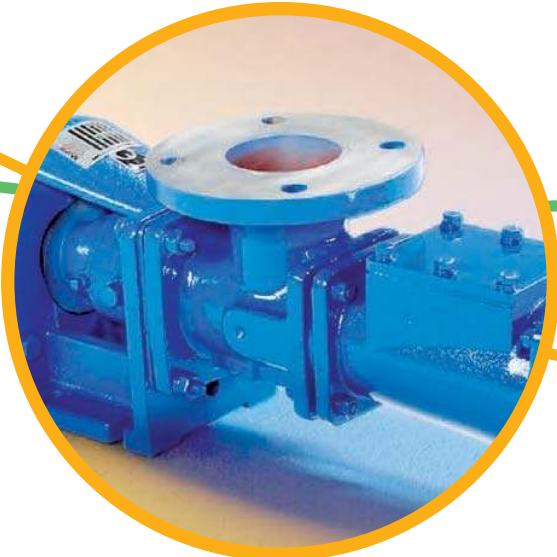

NOV Mono[®]

One Company, Unlimited Solutions

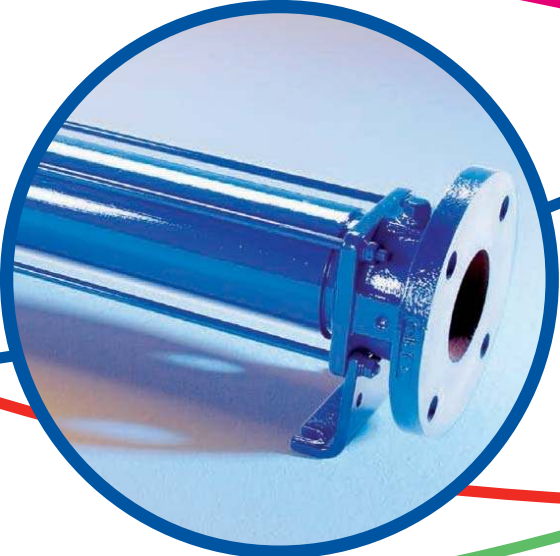
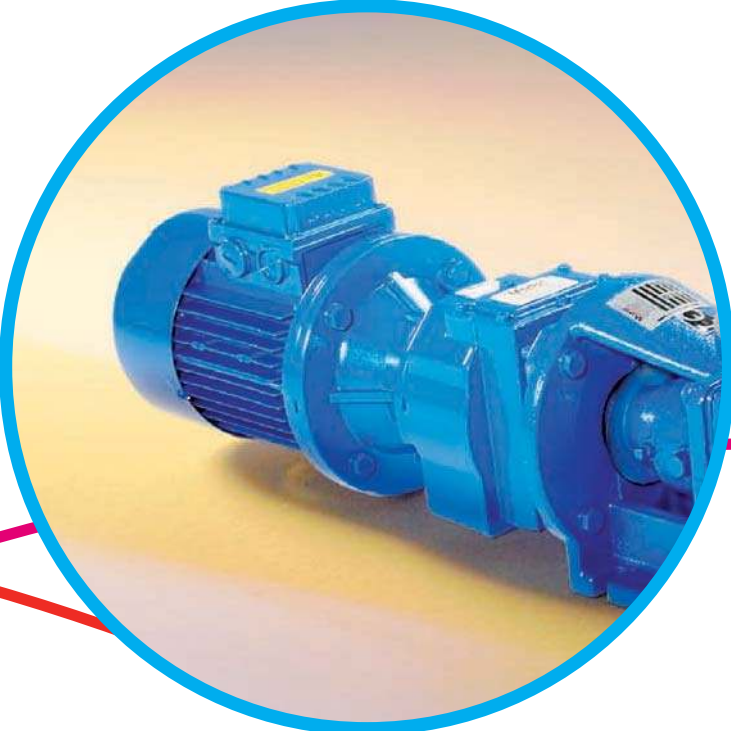

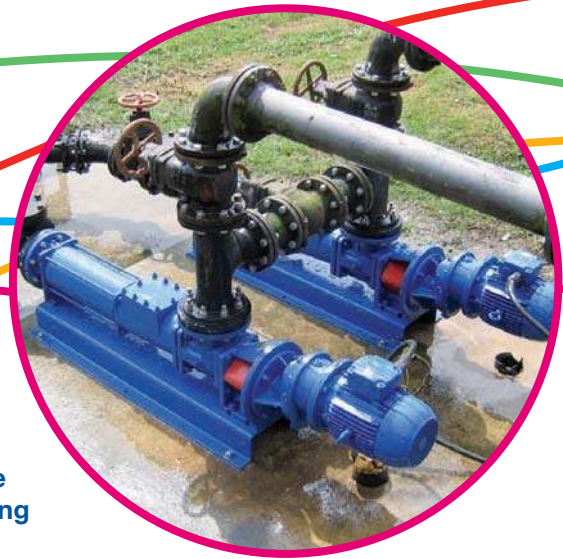

**Sludge
pumping**

Features & Benefits

Capacity	up to 440m ³ /h
Pressure	up to 24 bar
Temperature	-10°C up to 100°C

Typical applications include:

- Domestic and industrial effluents
- Hydrated lime slurry
- Sludge
- Shear sensitive latex emulsion
- Milk curds, sauces, fruit juices
- Industrial chemicals and detergents
- Starch slurries
- Coating clays, gypsum and silicate
- Paper stocks
- Agricultural slurries

“A competitively priced progressing cavity pump, with a compact construction and maximum performance characteristics.”

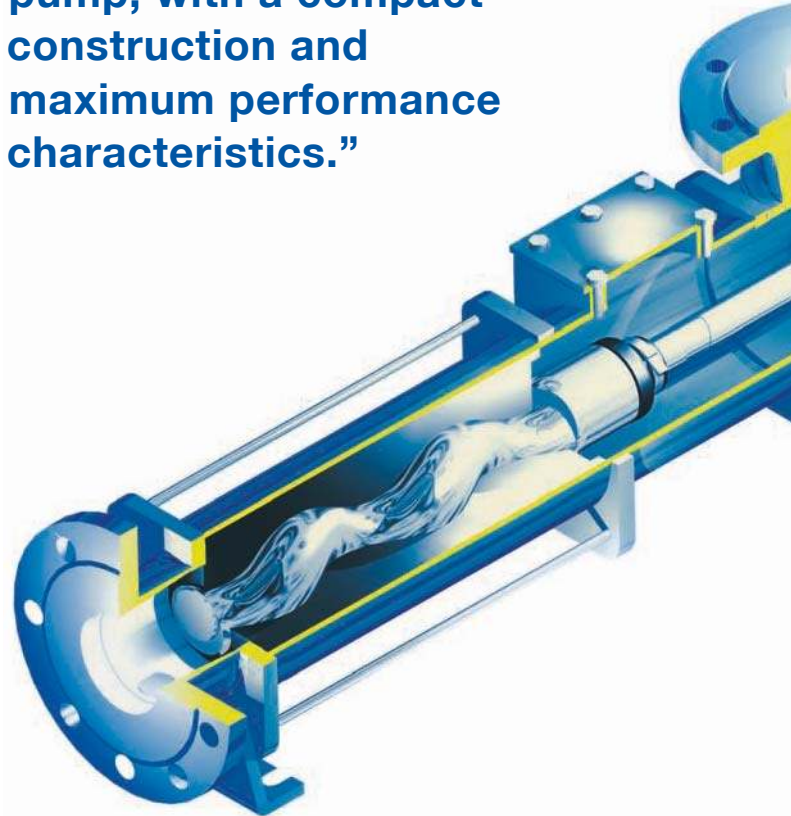

Materials of construction

Available in cast iron or stainless steel, with a choice of rotor and stator materials to suit individual applications e.g. hard chrome plated rotor or natural rubber stator.

High pressure / long haul pumping

Can offer considerable project cost savings by utilising small bore pipework and eliminating the need for a series of pumps, when pumping over long distances or with high head requirements.

Low running speeds

Reduced wear for a longer working pump life which extends the periods between routine maintenance. Think of the savings you could make on abrasive applications.



Waste water pumping

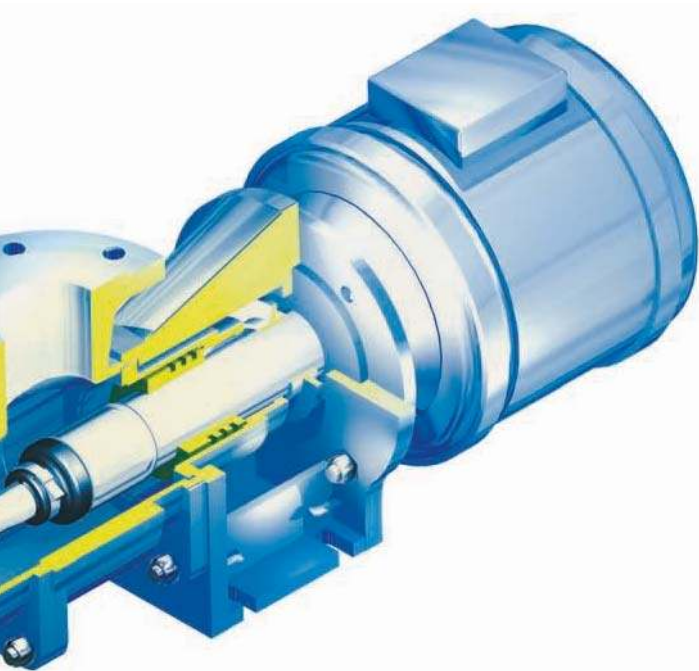

Compact unit

As the drive forms an integral part of the unit, the pump is ideal for space-saving installations.

Gentle pumping action

Minimises shear and crush damage to the pumped product.

Surface mounted

Making it easier, cleaner and less hazardous for maintenance.

Up to 8.5m suction lift

Deep sumps can be easily pumped without the use of submersible equipment.

Plug in shaft

Ease of maintenance when assembling or dismantling, with extraction facility.

Viscous products

The pump can be supplied with a square inlet and conveyor to assist viscous slurries into the pumping element.

Inspection cover

Available for applications where rag content is a problem.

Baseplate

Pumps are supplied on a baseplate to ease installation.

Sealed joints

Fully sealed drive train to maximise life and minimise downtime.

Shaft sealing options

Packed gland or single and double mechanical seals are available.

Versatile

Can be installed vertically or horizontally to suit the application. Can be run in either direction.

Robust drives

Specially selected drives and gearboxes for longer life. Options include electric motor drive units supplied as overhead vee belt driven, direct-coupled or variable speed drives with mechanical variable speed or frequency inverter.

Duracoat coating

Rotors can be supplied with Mono's range of specialist coatings to help extend the life of the rotors by increasing wear and corrosion resistance.

Handles gas entrainment

No air or gas locking in the pump. The positive seal formed by the interference fit between rotor and stator enables the pump to self prime and it also allows tri-phase liquids i.e. solids, gases and liquids to be handled easily.



Transfer of industrial detergents

Product Dimensions

MODEL	A	A1	B	C	D	E	F	G	H
C21B	429	115	296	133	1 1/4"	144	85	120	160
C21D	573	250	440	133	1 1/4"	144	85	120	160
C22A	429	115	296	133	1 1/4"	144	85	120	160
C22B	573	250	440	133	1 1/4"	144	85	120	160
C22D	959	525	822	137	1 1/2"	148	85	120	160
C23A	520	165	383	137	1 1/2"	148	85	120	160
C23B	665	300	528	137	1 1/2"	148	85	120	160
C23K	665	300	528	137	1 1/2"	148	85	120	160

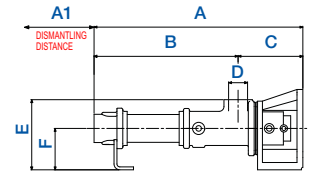

MODEL	A	A1	B	C	D	E	F	G	H
C1XK	750	300	593	157	50	190	85	120	160
C14K	986	455	756	230	65	227	112	140	200
C15K	1102	570	882	220	80	232	112	140	200
C16K	1272	680	1036	236	100	255	125	160	250
C17K	1478	800	1198	281	125	310	150	180	300
C18K	1654	880	1374	280	125	310	150	180	300
C19K	1856	990	1541	315	150	345	160	200	300
C1AK	2007	1100	1692	315	150	345	160	200	300
C1BK	2437	1210	2009	427	200	450	225	280	350
C13D	1160	525	930	230	65	227	112	140	200
C2XA	566	135	409	157	50	190	85	120	160
C2XB	749	315	592	157	50	227	112	120	160
C1XD	1363	650	1086	277	80	245	125	160	250
C14A	781	250	551	230	65	227	112	140	200
C14B	986	455	756	230	65	227	112	140	200
C14D	1462	780	1185	277	80	245	125	160	250
C15A	842	310	622	220	80	232	112	140	200
C15B	1159	570	882	277	80	245	125	160	250
C15D	1776	1005	1457	319	100	280	150	180	300
C16A	960	365	724	236	100	255	125	160	250
C16B	1355	680	1306	319	100	280	150	180	300
C16D	2181	1210	1813	369	125	320	160	200	300

MODEL	A	A1	B	C	D	E	F	G	H
C17A	1110	430	830	281	125	310	150	180	300
C17B	1478	800	1198	281	125	310	150	180	300
C17D	2626	1385	2224	402	150	410	225	280	350
C18A	1246	475	966	281	125	310	150	180	300
C18B	1742	880	1374	386	125	320	160	200	300
C18D	2786	1555	2384	402	150	410	225	280	350
C19A	1394	530	1079	315	150	345	160	200	300
C19B	1856	990	1541	315	150	345	160	200	300
C1AA	1476	610	1161	315	150	345	160	200	300
C1AB	2159	1100	1756	402	150	410	225	280	350
C1BA	1794	640	1366	427	200	450	225	280	350
C1BB	2591	255	2009	582	200	475	250	280	411
C1CA	2268	250	1611	657	250	511	250	340	411
C1CB	3146	250	2489	657	250	511	250	340	411
C1CK	3146	250	2489	657	250	511	250	340	411
C1DA	2569	250	1912	657	250	511	250	340	411

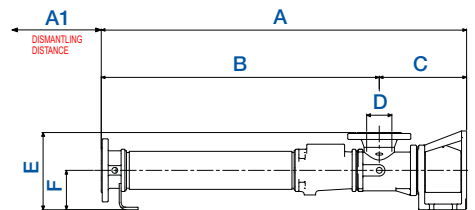
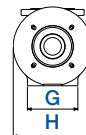

MODEL	A	A1	B	C	D	E	F	G	H
S14A	781	250	526	255	165x165	236	112	140	200
S14K	986	455	731	255	165x165	236	112	140	200
S15A	842	310	587	255	165x165	236	112	140	200
S15K	1102	570	847	255	165x165	236	112	140	200
S16A	960	365	674	286	200x200	260	125	160	250
S16K	1272	680	986	286	200x200	260	125	160	250
S17A	1110	430	777	333	240x240	310	150	180	300
S17K	1478	800	1145	333	240x240	310	150	180	300
S18A	1246	475	912	334	240x240	310	150	180	300
S18K	1654	880	1320	334	240x240	310	150	180	300

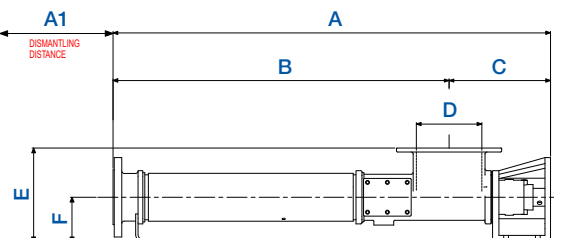
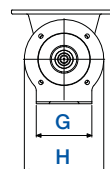

All dimensions in mm's, unless otherwise stated and for guidance only.
Dimension A1 is the preferred dismantling space. For full certified drawings, please contact Mono.



Pumping of slurry mix

Performance Data

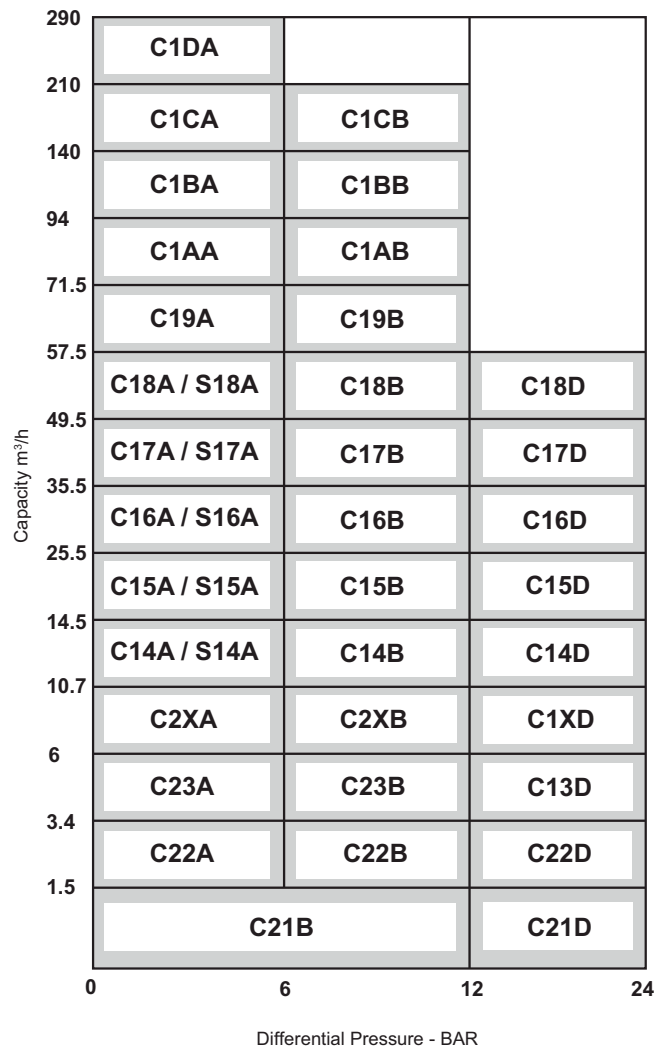
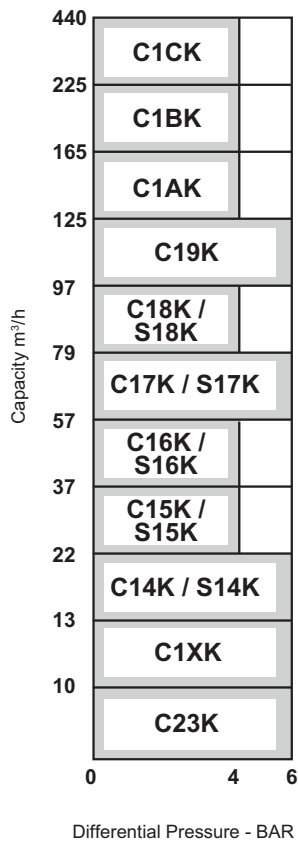

For guidance in selecting a pump, please contact Mono.

Motor/Baseplate Dimensions

MODEL	LENGTH	WIDTH	HEIGHT	MODEL	LENGTH	WIDTH	HEIGHT
C1XK	1304	300	304	C16A	1635	360	488
C14K	1665	300	475	C16B	2341	420	609
C15K	1777	360	475	C16D	3225	520	472
C16K	1947	360	488	C17A	2066	360	584
C17K	2464	360	609	C17B	2464	360	609
C18K	2640	420	609	C17D	3672	520	727
C19K	2902	420	649	C18A	2202	360	584
C1AK	3053	420	649	C18B	2788	420	649
C1BK	3481	520	537	C18D	3830	520	537
C13D	1835	360	475	C19A	2440	420	649
C2XA	1120	300	304	C19B	2902	420	649
C2XB	1329	300	304	C1AA	2522	420	649
C1XD	2038	420	488	C1AB	3205	520	727
C14A	1456	300	475	C1BA	2840	520	727
C14B	1665	300	475	C1BB	4350	752	892
C14D	2137	360	488	C1CA	4025	752	892
C15A	1517	300	475	C1CB	4900	778	943
C15B	1834	360	488	C1CK	4900	778	943
C15D	2762	420	609	C1DA	4350	752	892

MODEL	LENGTH	WIDTH	HEIGHT	MODEL	LENGTH	WIDTH	HEIGHT
S14A	1456	300	475	C21B	984	300	304
S14K	1665	300	475	C21D	1149	300	304
S15A	1517	300	475	C22A	984	300	304
S15K	1777	360	475	C22B	1149	300	304
S16A	1635	360	488	C22D	1544	300	304
S16K	1947	360	488	C23A	1084	300	304
S17A	2066	360	584	C23B	1234	300	304
S17K	2464	360	609	C23K	1234	300	304
S18A	2202	360	584				
S18K	2640	420	609				

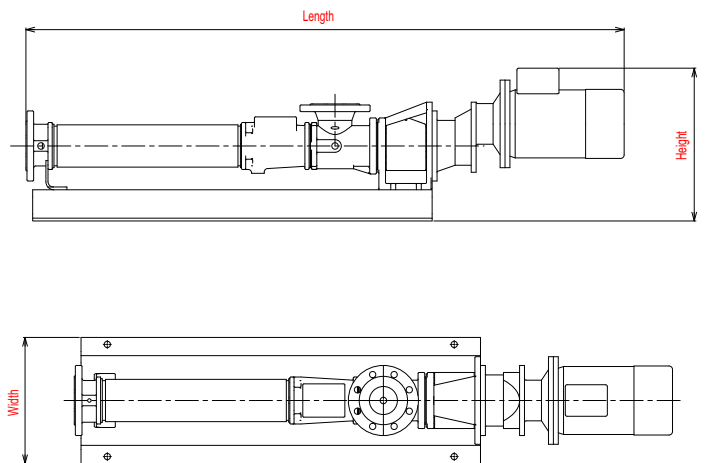

All dimensions in mm's and refer to the largest selected drive. Dimensions are for guidance only, for full certified drawings, please contact Mono.

Europe

Mono Pumps Ltd, Martin Street
Audenshaw, Manchester
M34 5JA, England
T. +44 (0)161 339 9000
E. info@mono-pumps.com

D.M.I EST, 56 rue du Pont
88300 Rebeuville, France
T. +33 (0)3 29 94 26 88
E. dmi-est@dmi-est.fr

Americas

MonoFlo, 9700 West Gulf Bank
Houston, Texas 77040, USA
T. +1 281 272 7700
E. inquire@monoflo.com

MonoFlo S.A., Ing Huergo 2239
(1842) Monte Grande
Pcia. de Buenos Aires, Argentina
T. +54 11 4290 9940/50
E. info@monoflo.com.ar

MonoFlo Canada
6010 - 53rd Ave
Alberta, Lloydminster
T9V2T2, Canada
T. +1 780 875 5584
E. info.monoflo@nov.com

Australasia

Mono Pumps (Australia) Pty Ltd
338-348 Lower Dandenong Road
Mordialloc, Victoria 3195
Australia
T. 1800 333 138
E. ozsales@mono-pumps.com

Mono Pumps (New Zealand) Ltd
PO Box 71-021, Fremlin Place
Avondale, Auckland 7
New Zealand
T. +64 (0)9 829 0333
E. info@mono-pumps.co.nz

Asia

Mono Pumps Ltd
No. 500 YaGang Road
Lujia Village, Malu
Jiading District
Shanghai 201801, P.R. China
T. +86 (0)21 5915 7168
E. monoshanghai@nov.com

www.mono-pumps.com



Published information other than that marked CERTIFIED does not extend any warranty or representation, expressed or implied, regarding these products. Any such warranties or other terms and conditions of sales and products shall be in accordance with Mono Pumps Limited standard terms and conditions of sale, available on request.

© Mono Pumps Limited May 2009 Literature reference: MPSB/01/01/R3

Mono® is a registered trademark of Mono Pumps Ltd.
Registered in England No 300721



One Company, Unlimited Solutions